



SIAT

M. J. MAILLIS GROUP

SK20 Semi Automatic Carton Sealers



RELIABLE MACHINE
Strong frame with dual masts structure



TIME SAVING SOLUTION
Fast removable top taping head

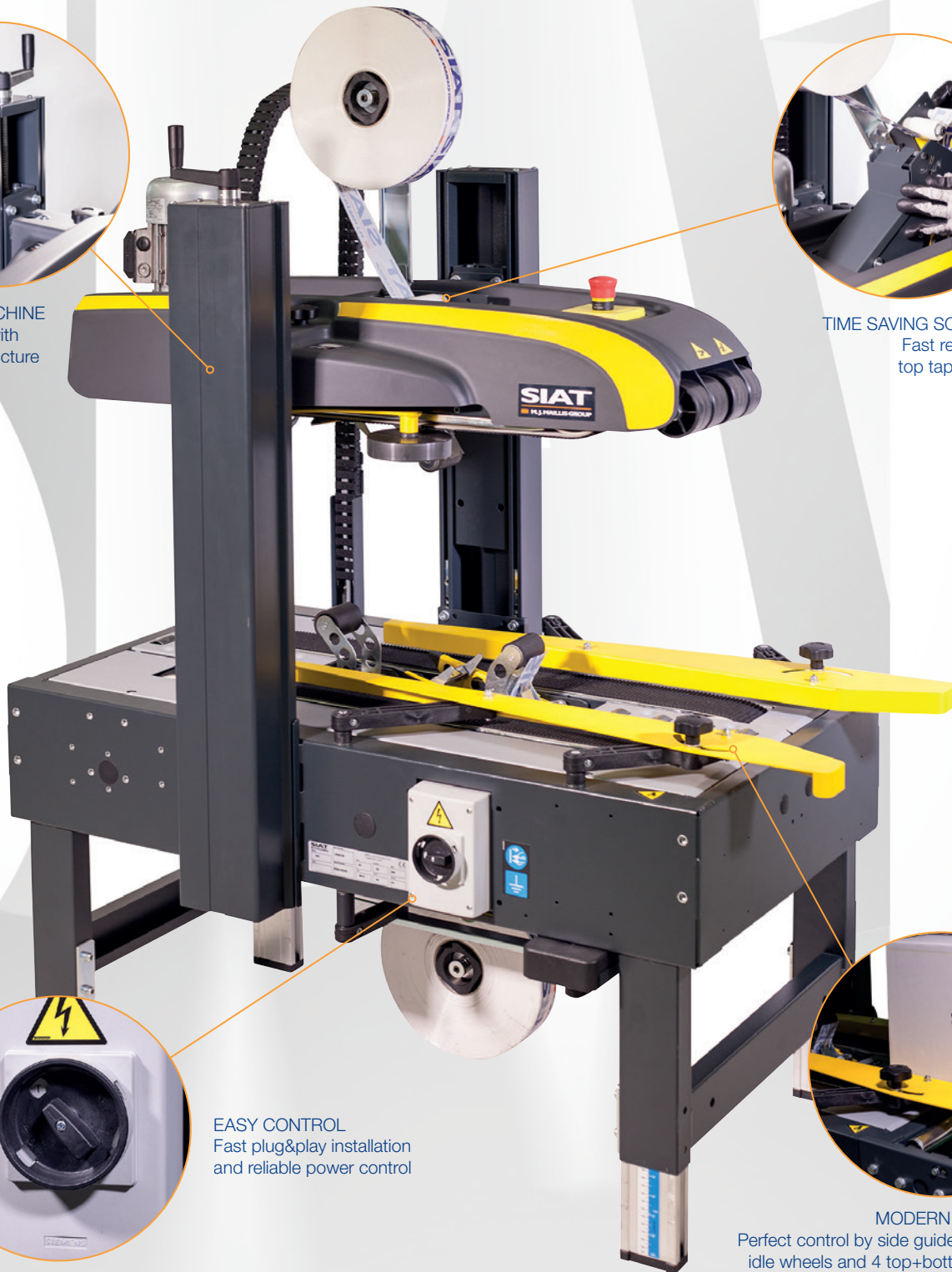

EASY CONTROL
Fast plug&play installation and reliable power control



MODERN DESIGN
Perfect control by side guides, upper idle wheels and 4 top+bottom belts



for more details:



SK20

The new case sealer SK20 represents the perfect solution for your semi-automatic packaging line.

The concept, with the double top and bottom drive belts, allows the control of the carton box also during the incoming process before sealing.

Thanks to the robust dual masts frame and to the primary level of the machine components, the historical reliability of SIAT machines is fully guaranteed.

The easy plug&play mode and the fast-removable taping head help the customer to save time efficiently during set-up and maintenance operations.

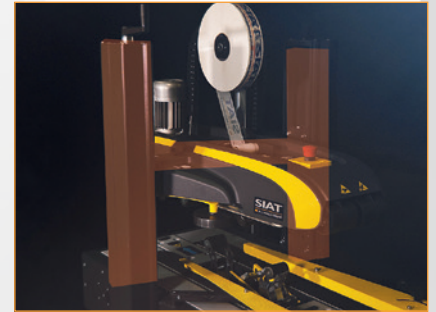
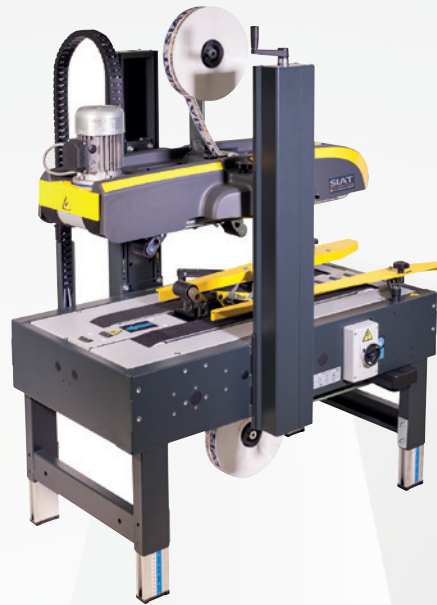

> **Machine dimensions**
Dimensioni macchina
Machinemessungen
Dimensions de la machine
Dimensiones de máquina

> SK20

Packaging size / weight			LxWxH
> SK20	160	175	114x78x115

	Min.	Max
L	1080	-
W	740	-
H	1290	1630
cbh	485	825
AS 77	cbh +110	cbh +110
AS 80	cbh +160	cbh +160

> SK20

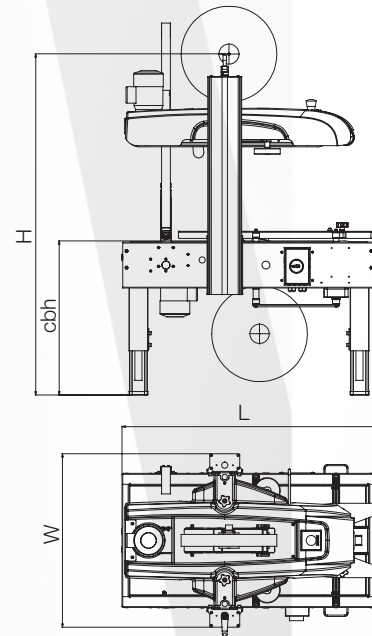

> **Box dimensions**
Dimensioni delle scatole
Kartonabmessungen
Dimensions des boîtes
Dimensiones de cajas

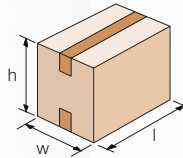

> SK20

	K11R std. / K12R on demand	
	Min.	Max
l	150	∞
w*	140 / 170	500
h	100	500

* With top side pressure rollers (minimum width manageable 205 mm).
Upper guides required in case of box width less than 205 mm (optional).

> **Production capacity**
Capacità di produzione
Produktionskapazität
Capacité de production
Capacidad de producción

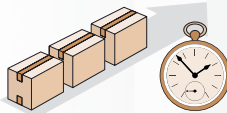

> SK20	Bph
Max pcs.*	1200

* Always based on shorter manageable box

> **Standard voltage**
Voltaggio standard
Standardspannung
Tension standard
Voltaje estándar

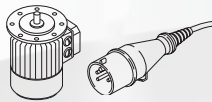

> SK20

380/415V - 50Hz - 3P	
Amps	1,08
Power kW	0,26
Phase	3Ph + PE

> **Taping units**
Unità nastranti
Verschliesseinheiten
Unités enrubanneuses
Unidades de precinto

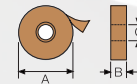

	K11R/ K12R	
	mm	
A	410 Max	
B	50 / 75	
C	76	

> **Optionals**
Accessori
Zubehör
Accessories
Accesorios

> **AS80**
Higher legs
Set gambe più alte
Höhere Stützen
Pieds plus hauts
Patas más altas

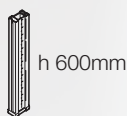

> **AS77**
Casters
Set ruote
Rädchen
Roulettes
Ruedas

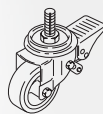

> **RG**
Roller conveyor
Piani a rulli
Rollenbahnen
Plans à rouleaux
Rodillos libres



> **GTL - GTR**
Extendable conveyor
Rulliera estensibile
Ausziehbare rollenbahnen
Convoyeur extensible
Rodillos extensibles

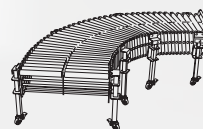

> **K-125 / K-250**
Inkjet printer
Stampante ad inchiostro
Tintenstrahldrucker
Marqueur à jet d'encre
Impresora de inyección de tinta

